



TECHNICAL DOCUMENTATION BELLOWS AIRSPRINGS

ESP/96A - Edition 07/2002

DUNLOP AIRSPRINGS

S.A.S. au capital de 3 600 525 €
Siège social : 8 rue Lionel Terray
92500 Rueil-Malmaison
N° Identification TVA 08420866832
N° 420866832 RCS Nanterre



TABLE OF CONTENTS

Introduction	2
Examples of Applications	3
Selection criteria for an air bellows and Precautions in use	5
Dimensions	5
Load / Pressure	5
Angular capability / Out of alignment	6
Isolation	7
Temperature	7
Environment	7
Geometrics characteristics	8
Dismountable bellows technical datas	
Bellows 2"¾	12
Bellows 4"½	24
Bellows 6"	30
Bellows 8"	46
Bellows 9"¼	52
Bellows 10"	54
Bellows 12"	62
Bellows 14"½	78
Bellows 16"	88
Bellows 21"½	94
Bellows 26"	96
Crimped bellows technical datas (does exist in stainless steel version)	
Bellows 8"	100
Bellows 9"¼	104
Bellows 12"	110
Warranty conditions	120

SPRINGRIDE® convoluted bellows have been manufactured since 1960 by *DUNLOP AIRSPRINGS* in the Montluçon factory.

They are used in industry as **rubber actuators** or **vibration isolators** for various applications :

- Lifting,
- Locking device,
- Shock absorber,
- Isolation of vibrating machines,
- Etc.

SPRINGRIDE® convoluted bellows are used in most industrial fields, from the smallest lift tables to the largest paper machines, including applications as varied as irrigation systems, garage equipment and childrens roundabouts.

Thanks to a policy of permanent innovation and with one of the largest existing ranges of dismantable and crimped convoluted bellows, from 2" $\frac{3}{4}$ x 1 to 26" x 2, *DUNLOP AIRSPRINGS* is leader in the **European Industrial Market**.

As a result of the most demanding quality and reliability requirements, **SPRINGRIDE®** air bellows are also employed in the Automotive (air suspensions for industrial vehicles, trucks, trailers and buses) and Railway industries (air suspensions for underground trains and pantographs lifts).

SPRINGRIDE® rubber actuators, compared with traditional products (rigid actuators, spring...) offer numerous advantages such as :

- Flexibility (no angle or alignment problem),
- Compactness,
- Power / price ratio,
- No maintenance or lubrication required,
- Durability,
- Reliability,
- Resistance to aggressive or hot conditions.

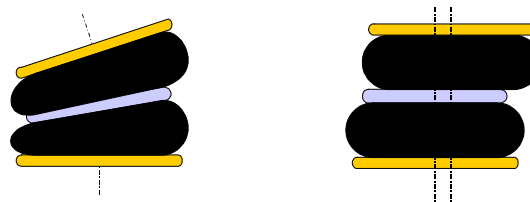

The current standard range of **SPRINGRIDE®** convoluted rubber bellows is shown.

Most of the range can be easily supplied with various options (such as different air inlets, specific fixings, etc.)

The main technical characteristics of each rubber bellows are indicated in order to identify easily and quickly the best product to meet specific requirements.

Relying on technological knowledge of rubbers, polymers and textiles, **DUNLOP AIRSPRINGS** can also supply a choice of specific compounds in order to meet the requirements involved for applications in severe environments (resistance to hydrocarbons, high temperatures, etc.).

EXAMPLES OF APPLICATIONS

ISOLATORS

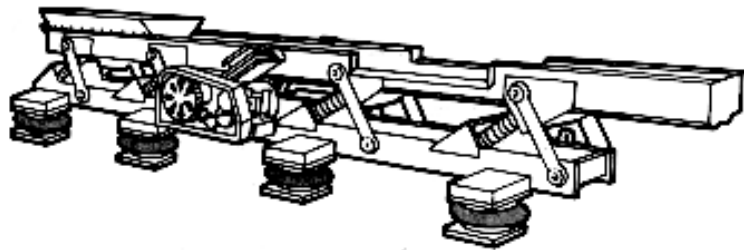

OSCILLATE CONVEYOR

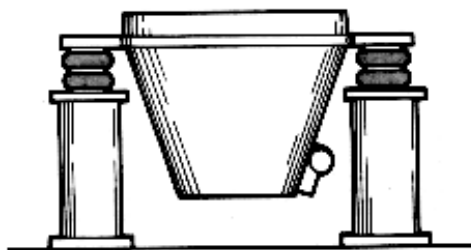

VIBRATING BIN HOPPER

EXAMPLES OF APPLICATIONS

ACTUATORS

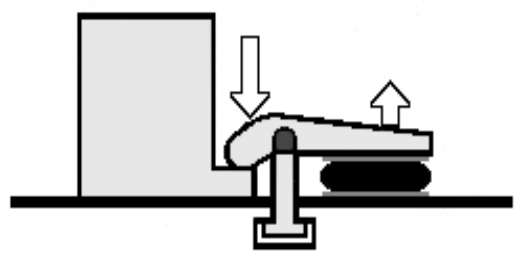

CLAMP DEVICE

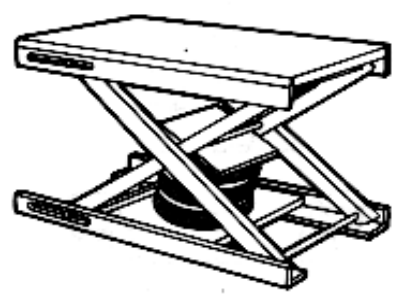
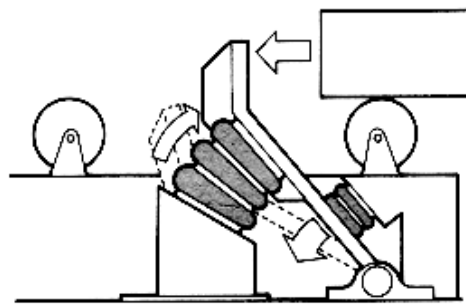

TABLE LIFTER



LEVEL PLATFORMS



BUMPER AND ACTUATOR

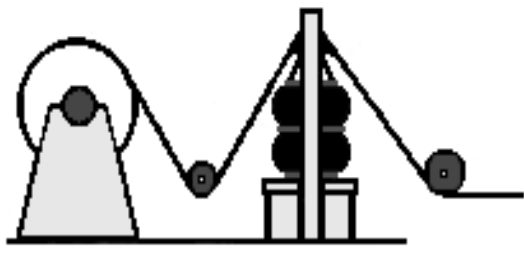

WEBB TENSIONING DEVICE

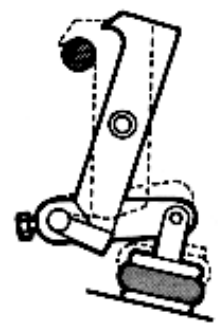

QUICK LOCK DEVICE

SELECTION CRITERIA FOR AN AIR BELLOWS AND PRECAUTIONS IN USE

DIMENSIONS

- The available space must be greater than the air bellows overall diameter.
- The high position of your application must be lower than the air bellows maximum height.
- The low position of your application must be higher than the air bellows minimum height.

Example : bellows 12"x2

Heights (mm) (H)			Stroke (mm)
Maximum	Minimum	Static	
300	75	170	225
Diameters (mm)			Weight (kg)
Ø MAX	Overall		
325	350		6.7

LOAD / PRESSURE

To ensure that the air bellows is capable of the required force, please use the graph of the load versus height at fixed pressure (2, 4, 6 or 8 bar). Please note that unlike the traditional rigid actuator, the air bellows force decreases when the height increases.

You can also use the static force table.
For higher pressure than 8 bar, we strongly recommend the use for reinforced air bellows.

examples: (for 12"X2 air bellows)

- What is the force at 170 mm height for pressures of 6 bar and 5 bar ?

For 6 bar : we read 2 900 daN (Example **A**).
For 5 bar : $2900/6 \times 5 \approx 2420$ daN.

- What is the maximum height to lift a load of 1800 daN with a pressure of 6 bar ?

We read : 245 mm (Example **B**)

- What is the pressure for a load of 2200 daN at the height of 90 mm ?

We obtain point (**C**).
You must look at the nearest load curve and read the force at the same height of 90 mm.
We obtain 2 485 daN with 4 bar.

The pressure equals : $4 \times \frac{2200}{2485} = 3.5$ bar.

Volume V (dm³) at 6 bar Load (daN)

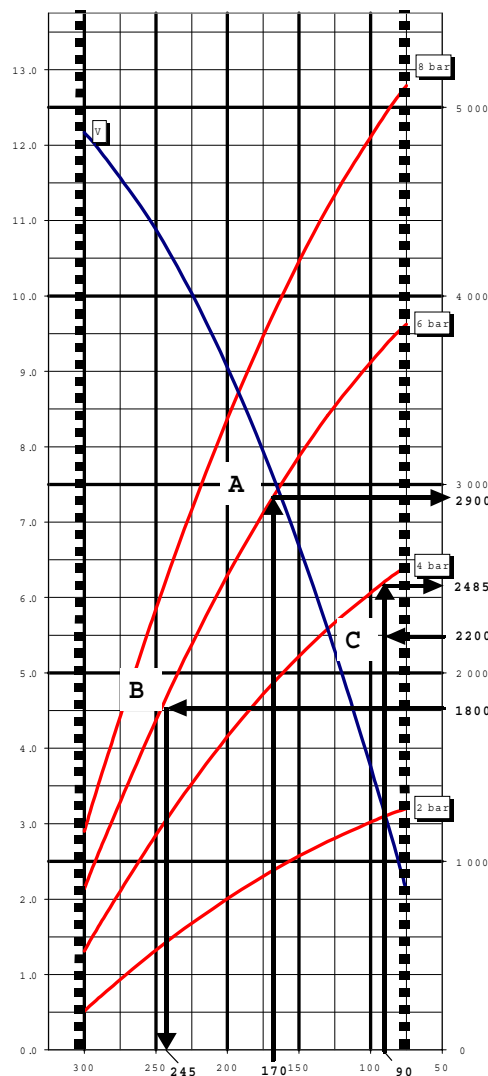

Height (mm)

ANGULAR CAPABILITY/ OUT OF ALIGNMENT

Compare the angular and out of alignment conditions of your applications with those of the air bellows, see tables.

So, for the 12" x 2 bellows, an angle of 20° is available for heights between 115 and 235 mm.

For applications with an angular motion combined with an out of alignment, please contact our technical sales department.

Example : bellows 12"x2

ANGULAR CAPABILITY

Maximum (α)	For H between	
	H mini (mm)	H maxi (mm)
10°	100	255
15°	110	245
20°	115	235
25°	160	225

OUT OF ALIGNMENT

Maximum (A) (mm)	For H between	
	H mini (mm)	H maxi (mm)
10	105	270
20	130	260
30	150	245
40	175	230

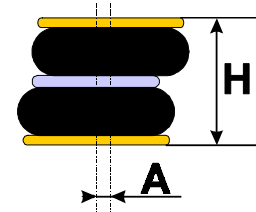
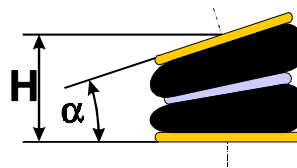

ISOLATION

We recommend a mounting height for each air bellows, which gives the best performances for isolation (example : 220 mm for 12" x 2). We indicate the natural frequencies of the air bellows at pressures of 2, 4 and 6 bar (+ 8 bar in case of reinforced). The isolation rate is calculated with the following formule:

where : fe = exciting frequency (Hz)
 fn = air bellows natural frequency (Hz)
 I = isolation rate (%)

$$I = 1 - \frac{1}{\left(\frac{f_e}{f_n}\right)^2 - 1}$$

Many other parameters must be considered.

Stability

The distance between 2 air bellows must be at least twice the height difference between the centre of gravity and the mounting plane of the air bellows.

Lateral vibrations

The air bellows have a low lateral rate, it is recommended to provide bumpers to limit the amplitude of the lateral vibrations.

Startup - shutdown

During startup and shutdown of the vibration sources, the loads supported by the air bellows will be important. In order to avoid the damage of the air bellows, we recommend to use stops which limit the height range (for example ± 10 mm from mounting height).

Auxiliary tank

The addition of a tank gives an increased volume, which reduces the air bellows natural frequency and improves the isolation. In order to be effective, the tank must be placed as close as possible to the air bellows and connected with piping allowing an important flow.

Do not hesitate to contact our technical sales department.

PRECAUTIONS IN USE

- Airsprings must not be pressurised unless they are restricted by an outside frame or by a suitable load.
- Strokes must be limited by the direct use of bump stops or external stops.
- When stacking airsprings, special care must be taken to ensure the airsprings are guided and fixed.
- An Airspring is a single acting air actuator and must not be used below atmospheric pressure.
- Please check the over-pressure in case of rapid compression.

TEMPERATURE

According to the temperature conditions, the rubber compound must be chosen as follows :

STANDARD :	- 40°C to + 70°C
BUTYL :	- 25°C to + 90°C
EPICHLOR :	- 20°C to + 115°C

ENVIRONMENT

Some products such as acids or hydrocarbons may cause problems to the air bellows. The resistance of air bellows depends on the compound. Epichlorohydrin, for the instance, is the best with hydrocarbons. A special treatments is available to increase the resistance against ozone and U.V.

In any case, please contact our technical sales department.

IMPORTANT :

The information contained in this document was determined from real situation tests and measures which were carried out in a laboratory. This information should help to guide our customers in defining the best solution for its application and was subject to validation at the time when the present document was published. However, DUNLOP AIRSPRINGS reserves the right to change or modify this information without prior notice.

Extract from general terms of sale :

" The acquisition, marketing or the use of DUNLOP merchandise imply the knowledge of and compliance with their characteristics and with the conditions of their implementation.

It is the responsibility of customers to be perfectly informed of these characteristics, to take these characteristics into consideration and to ensure the passing on of this information to users. No modification can be brought to DUNLOP merchandise which are intended to be resold or used in their present state.

The liability of DUNLOP cannot be incurred in the event of an unsuitable and/or abnormal installation or use of the said products."

GEOMETRIC CHARACTERISTICS



	ØMax	Øe	Stroke	Height H (mm)			Load (daN) at 6 bar			nf *	Stiffness*	Weight
	(mm)	(mm)		min.	design	Max.	H.min.	H.design	H.Max.			
2"³/₄x1 Composite	80	95	20	50	60	70	260	173	92	4.60	133.7	0.22
2"³/₄x1 Aluminium	80	95	20	50	60	70	260	173	92	4.60	133.7	0.35
4"¹/₂x1 Aluminium	125	140	40	50	70	90	550	355	140	3.71	184.9	0.75
6"x1 Composite	175	190	55	55	80	110	1140	755	330	3.33	272.2	0.95
6"x1	175	190	55	55	80	110	1140	755	330	3.33	272.2	1.9
6"x1	175	190	55	50	75	105	1095	710	290	3.30	249.0	2.2
8"x1	230	245	80	50	90	130	1860	1275	535	2.77	342.1	3.0
S.8"x1	225	240	95	60	105	155	1630	1210	460	2.47	265.3	1.8
S.9"¹/₄x1	255	275	105	55	105	160	1960	1560	825	2.17	281.4	2.3
10"x1	280	300	100	50	100	150	2645	1960	900	2.46	385	3.9
12"x1	330	350	100	50	100	150	3885	2975	1510	2.44	588	5.4
S.12"x1	335	360	105	60	110	165	3900	2950	1385	2.26	530	3.9
14"¹/₂x1	395	425	125	50	110	175	5760	4555	2155	2.22	784	7.1

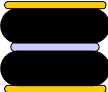

	ØMax	Øe	Stroke	Height H (mm)			Load (daN) at 6 bar			nf *	Stiffness*	Weight
	(mm)	(mm)		min.	design	Max.	H.min.	H.design	H.Max.			
2"³/₄x2 Composite	80	95	45	65	90	110	213	139	54	3.60	72.5	0.26
2"³/₄x2 Aluminium	80	95	45	65	90	110	213	139	54	3.60	72.5	0.40
4"¹/₂x2 Aluminium	125	140	85	65	100	150	575	400	170	2.62	71.4	0.95
6"x2 Composite	175	190	115	80	140	195	1060	685	340	2.25	114.0	1.3
6"x2 Aluminium	175	190	115	80	140	195	1060	685	340	2.25	114.0	2.2
6"x2	175	190	115	75	140	190	1040	635	320	2.25	116.9	2.6
8"x2	220	245	175	75	160	250	1765	1140	445	1.95	128.1	3.7
S.8"x2	220	240	185	80	175	265	1650	1050	395	1.89	125.1	2.5
9"¹/₄x2	255	270	205	75	160	280	2315	1730	745	1.72	150.4	5.5
S.9"¹/₄x2 NB	255	275	220	80	175	300	2015	1380	490	1.65	120.6	2.8
S.9"¹/₄x2 ANB	265	285	290	80	260	370	2790	1475	705	1.51	118	3.1
10"x2	270	300	225	75	170	300	2635	1900	645	1.75	178.8	4.9

* : Value for recommended height for better isolation at pressure 6 bar

ØMax : Maximum diameter
 Øe : Overall diameter
 nf : Natural frequency

H.min : minimum height
 H.design : Design height
 H.Max : maximum height

S.xxxxxx : crimped version

GEOMETRIC CHARACTERISTICS



	ØMax	Øe	Stroke	Height H (mm)			Load (daN) at 6 bar			nf *	Stiffness*	Weight
	(mm)	(mm)	(mm)	min.	design	Max.	H.min.	H.design	H.Max.	(Hz)	(daN/mm)	(kg)
12"x2	325	350	225	75	170	300	3850	2910	855	1.78	285	6.7
S.12"x2	325	350	215	85	190	300	3580	2800	1175	1.68	276	5.3
12"x2 NB	325	350	225	75	170	300	3905	2905	930	1.76	277	6.2
S.12"x2ANB	345	370	265	80	270	345	4310	2060	975	1.59	243	5.0
12"x2 ANB	345	370	325	75	270	400	4590	2790	1295	1.45	205	6.9
14"½x2	400	425	265	75	200	340	6195	4445	1690	1.61	373	8.9
14"½x2 Re	390	425	230	90	200	320	5585	4025	1680	1.66	370	9.4
16"x2	440	460	315	75	200	390	6525	5195	2020	1.44	323	9.5
16"x2 Re	430	460	300	90	200	390	6255	5040	1745	1.48	339	10.1
21"½x2	580	630	280	90	200	370	14150	11690	5345	1.50	756	21.0
26"x2	700	750	410	90	200	500	20370	17335	8445	1.23	792	23.7

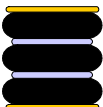

	ØMax	Øe	Stroke	Height H (mm)			Load (daN) at 6 bar			nf *	Stiffness*	Weight
	(mm)	(mm)	(mm)	min.	design	Max.	H.min.	H.design	H.Max.	(Hz)	(daN/mm)	(kg)
2"³x3 Composite	80	95	60	80	110	140	230	157	70	3.12	50.7	0.3
2"³x3 Aluminium	80	95	60	80	110	140	230	157	70	3.12	50.7	0.5
4"½x3 Aluminium	125	140	100	100	145	200	535	375	230	1.96	36.8	1.2
6"x3 Aluminium	175	190	190	100	190	290	1055	725	295	1.85	77.3	2.6
6"x3	175	190	190	95	190	285	1045	690	280	1.85	75.5	2.8
8"x3	215	240	250	100	230	350	1740	1075	465	1.60	85.1	4.4
10"x3	270	300	330	100	250	430	2660	1770	645	1.43	110	5.9
10"x3 Re	270	300	300	120	250	420	2585	1740	685	1.46	107	6.3
12"x3	325	350	330	100	250	430	4060	2930	1090	1.44	189	8.1
S.12"x3	325	350	345	120	265	465	3810	2700	660	1.42	178	7.0
12"x3 NB	335	360	335	100	250	450	4165	2950	985	1.41	178	7.5
12"x3 Re	325	350	300	120	250	420	4145	3065	1130	1.48	273	8.6
12"x3ReNB	325	350	320	120	250	440	3885	2860	855	1.48	187	7.6
S.12"x3RNB	325	350	315	105	265	420	3825	2505	955	1.44	174	7.0
14"½x3	400	425	380	100	290	480	6255	4320	1920	1.31	233	10.5
14"½x3 Re	390	420	330	120	290	450	5715	4090	1940	1.37	254	11.4
16"x3 Re	425	450	430	120	290	550	6495	5145	1905	1.24	244	12.5

* : Value for recommended height for better isolation at pressure 6 bar

ØMax : Maximum diameter
 Øe : Overall diameter
 nf : Natural frequency

H.min : minimum height
 H.design : Design height
 H.Max : maximum height

S.xxxxxx : crimped version

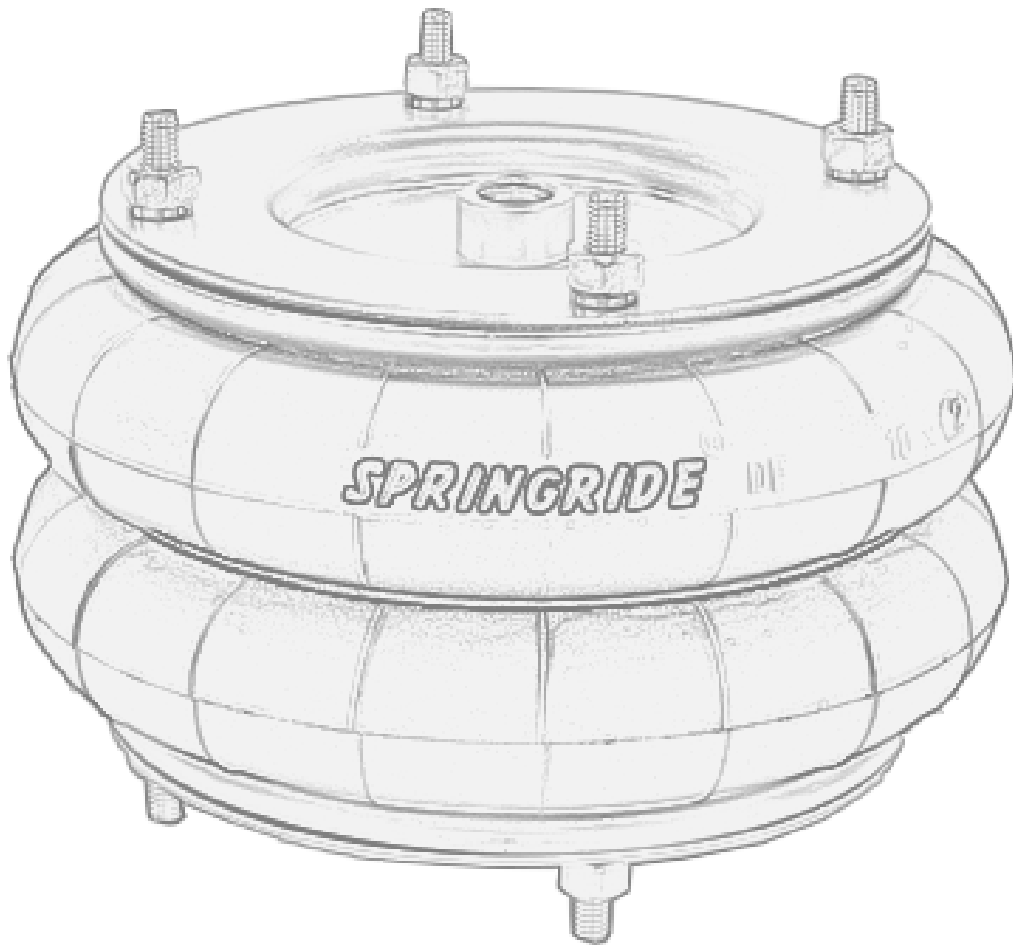

DISMOUNTABLE BELLOWS RANGE