

NOTE: All Assembly Order Numbers are for bead ring parts unless noted otherwise.

	Description	Assembly Order No.
Style 148-1	Ribbed neck aluminum bead rings (equal spacing), 45 mm bolts, nuts, washers	W01-M58-6969
High Strength Construction	Rubber bellows only	W01-358-1021
Assembly weight.....		21.00 kg.
Force to collapse to minimum height (@ 0 BAR)		1378 N.

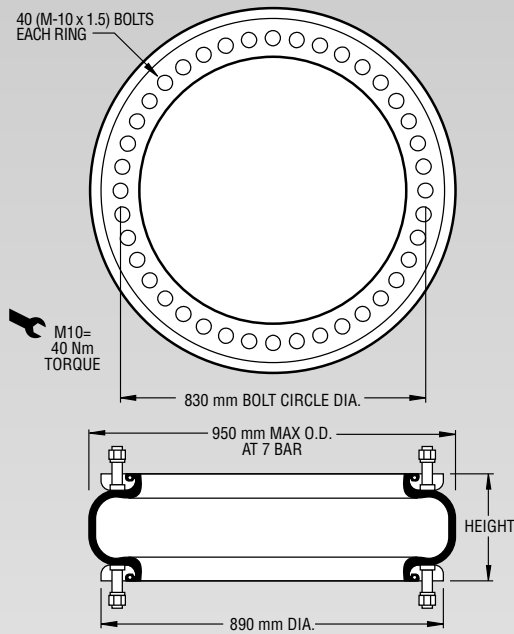

NOTE: The effective length of the 45 mm bolt is 23 mm in this bead ring.

Gauge Pressure (BAR)	Load (kN)	Spring Rate (kN/m)	Natural Frequency Hz
3	159.12	2747	2.07
4	214.60	3485	2.01
5	268.86	4248	1.98
6	327.14	5077	1.96
7	381.44	5830	1.95

RECOMMENDED
AIRMOUNT
DESIGN HEIGHT
140 mm.

Static Data
8411

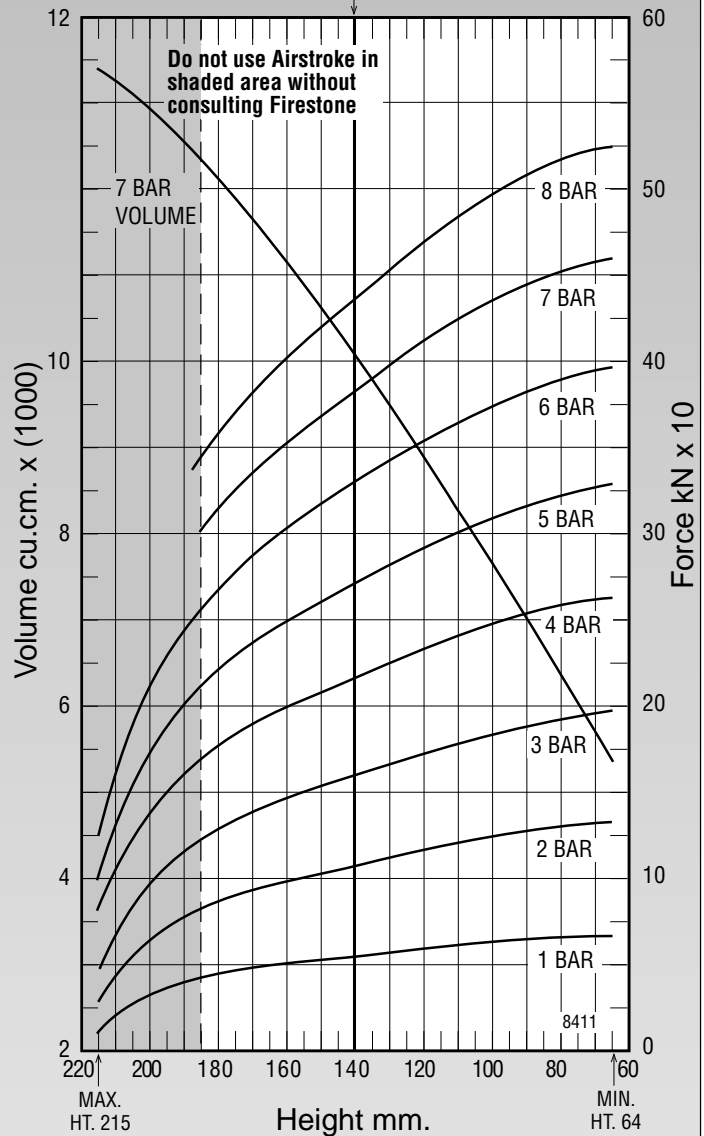

See page 12 for instructions on how to use chart.

Assembly Height (mm)	Volume @ 7 BAR (cu cm)	EFF Area @ 7 BAR (cm sq)	kN Force				
			@ 3 BAR	@ 4 BAR	@ 5 BAR	@ 6 BAR	@ 7 BAR
180	100532	4456	126.24	174.51	218.75	266.95	311.89
160	90826	4998	144.99	197.24	247.10	300.31	349.83
140	79989	5450	159.12	214.60	268.86	327.14	381.44
120	68618	5857	170.91	230.51	289.23	351.92	409.95
100	56587	6199	181.41	245.45	307.57	373.08	433.88
80	44091	6455	191.45	257.88	321.60	388.59	451.81