



GRA61741A0 Rear Land Rover Defender 90, Discovery & Disco Series2 GS Air Helper Springs Kit

Congratulations on your purchase of an Airlift Coil Spring Helper Kit.

INSTALLATION

Read Airlift Instructions MN-285 as supplied with the standard kit for general information and refer to Step 6 of the Installation Instructions i.e.

6. Insert large spacer into the coil. Route the air line through the hole in the spacer and push spacer into the hole in the upper spring seat (Figure 2). Route airline horizontally through groove in the spacer. Repeat this process for the other side.



The spacer has a collar (see left), with the narrow part having a diameter of 107 mm

Supplied By

Gremeltech cc
Tel 021 551 9099
Fax 021 552 9298

Email

Gremeltech@absamail.co.za

Web

www.airsprings.co.za

No 10, 5th Street
Montague Gardens 7441

Fitting the Top Spacer.



Use a 12" shifting spanner (see left) to bend the inside bottom edge of the top spring seat inwards until it fits the inside edge of the collar on the spacer. i.e. the new diameter of the **spring seat** opening will be **107mm** and the edge of the spring seat will move anywhere from 0-5mm closer to the centre.



The fit of the spacer should be tight so that it **cannot fall downwards**.

The collar stops the spacer being pushed upwards through the spring seat at an angle so it is critical that there is **no sideways movement** of the spacer in the spring seat.

AIR LIFT 1000

BY
AIR LIFT

MN-285
(02706)
ECN2200

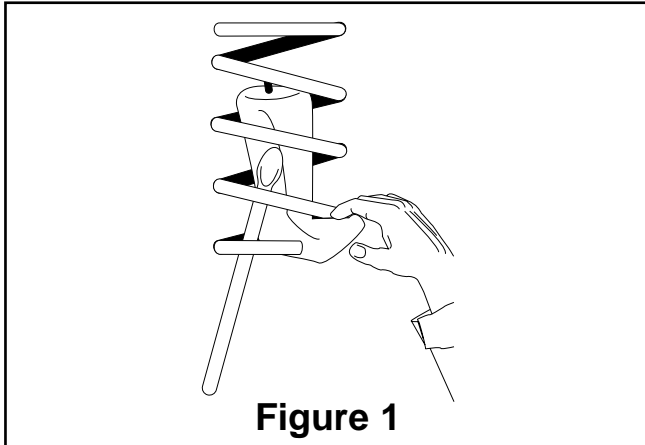

Figure 1

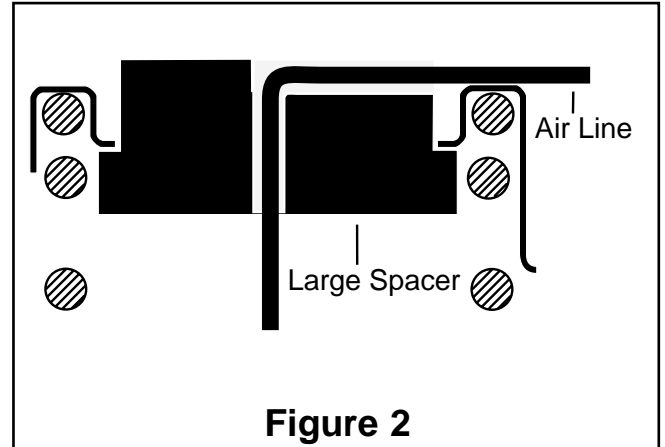

Figure 2

1. Jack up rear of vehicle or raise on hoist. Support frame with safety stands. Remove lower shock absorber attaching bolts.
2. Carefully lower axle or raise body of vehicle until suspension is fully extended. **CAUTION: Observe tension on brake line-Do Not Strain.** The coil springs must be removed from the upper spring seat for this installation:
 - a. Detach the shock absorbers at the lower shock mount.
 - b. Carefully lower the axle until the coil springs are free from the upper spring seat. **Do not strain brake lines.**
3. Insert the lower protector in the bottom of the coil spring (Figure 3). Position the holes of the protector over the bolt heads in the lower spring seat.
4. Insert the air cylinder into the coil with the valve stem at the top (Figure 1).
5. Cut the air line in equal lengths and slide on air line clamp over one end. Push the air line onto the stem of air cylinder, covering all the barbs. With pliers slide the air line clamp downward until it fully covers the barbed section (Figure 5).
6. Insert large spacer into the coil. Route the air line through the hole in the spacer and push spacer into the hole in the upper spring seat (Figure 2). Route airline horizontally through groove in the spacer. Repeat this process for the other side.
7. Carefully raise the axle to seat the coil springs in the upper spring seats.
9. Reconnect the shock absorbers.
10. Install the heat shield. Separate instructions are included with the heat shield.

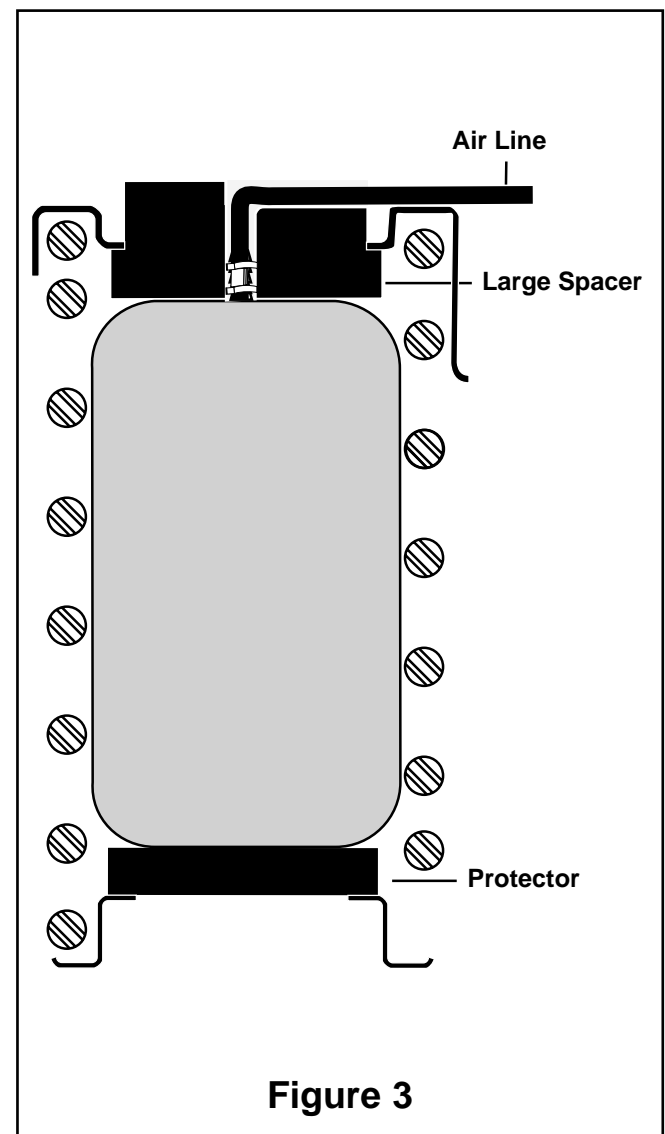
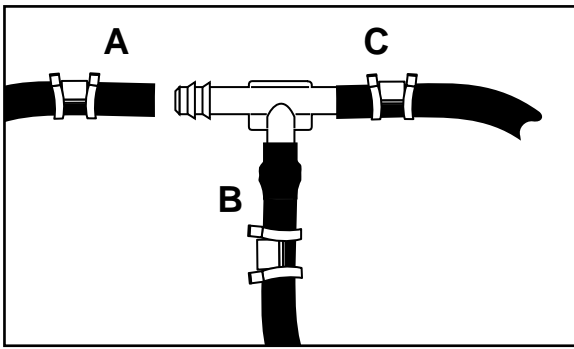

Figure 3



Use this procedure for all air line connections:
A. Slide air line clamp onto the air line
B. Push the air line over the barbed stem.
C. Compress the ears on the air line clamp with pliers and slide it forward to fully cover the barbed section.

Figure 4

DO NOT INFLATE AIR CYLINDERS BEFORE READING MAINTENANCE/OPERATION TIPS. SEE PAGE 4 FOR INFLATION PROCEDURES.

Tee air line installation recommended unless weight in vehicle varies from one side to the other and unequal pressures are needed to level the load. Dual air lines are used in this case.

TEE AIR LINE ROUTING

TO PREVENT AIR LINE FROM MELTING, KEEP IT AT LEAST EIGHT INCHES FROM EXHAUST SYSTEM.

- A. Locate desired tee location on the frame rail or cross member.
- B. Route along cross member from the upper spring seat to tee location. Attach with provided plastic straps.

CAUTION: LEAVE SUFFICIENT AIR LINE SLACK TO PREVENT ANY STRAIN ON FITTING DURING AXLE MOTIONS.

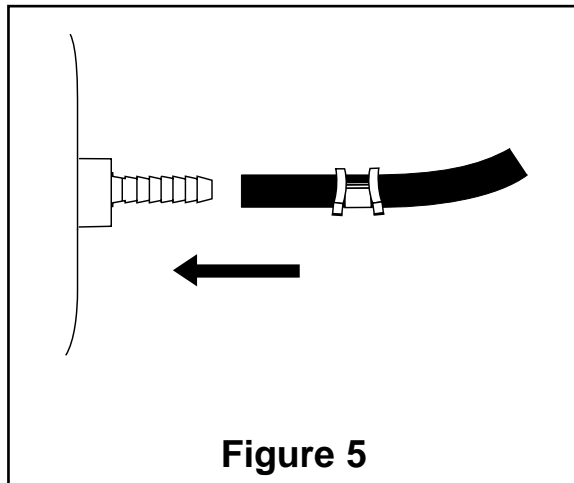

Figure 5

- C. Cut off excess air line and slide air line clamp onto the air line. Push the air line over one side of the tee until all the barbs are covered. Repeat procedure for other leg of tee.

- D. With pliers slide the air line clamp forward until it fully covers the barbed section. Repeat for the air line from the other air cylinder (Figure 4).

- E. Select a location for inflation valve in the gas cap well, the trunk, rear bumper, fender flange or behind the license plate, assuring that the valve will be protected and accessible with an air hose (Figure 6).

- F. Drill a 5/16" hole for inflation valve and mount as in illustration (Figure 8). Rubber washer is for outside weather seal.

- G. Push the remaining air line over the last fitting on tee and route along frame to desired inflation valve location (Figure 6). Attach with plastic straps or wire.

- H. Slide air line clamp over the air line. Push air line onto fitting covering all barbs, with pliers slide the air line clamp forward until it fully covers the barbed section (Figure 7).

- I. Raise axle or lower body until air cylinders lightly touch lower spring protector and upper spacer. **NOTE-Check to be sure the air line does not kink or become pinched between the spacer and cylinder or floor pan.**

- J. Continue with step 13.

DUAL AIR LINE ROUTING

TO PREVENT AIR LINE FROM MELTING, KEEP IT AT LEAST EIGHT INCHES FROM EXHAUST SYSTEM.

- A. Select a location for the inflation valves in the rocker panel flange, or rear bumper, assuring that each valve will be protected and accessible with an air hose (Figure 9).

- B. Drill 5/16" hole for inflation valves and mount as illustrated. Rubber washer is for outside weather seal (Figure 8).

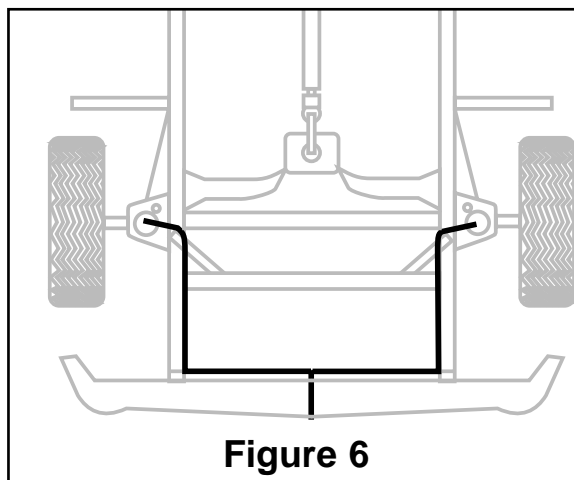
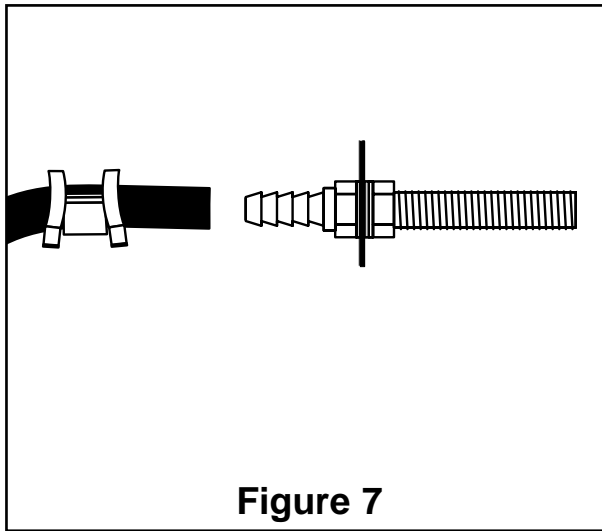

Figure 6



C. Route air line along control arm and frame to inflation valve location and cut off excess air line. Attach with plastic straps or wire.

CAUTION: LEAVE SUFFICIENT AIR LINE SLACK TO PREVENT ANY STRAIN ON VALVE STEM DURING NORMAL AXLE MOTIONS.

D. Slide air line clamp onto the air line and push the air line over the fitting, covering all the barbs. With pliers slide the air line clamp forward until it fully covers the barbed section.

E. Repeat process for the other side.

F. Raise axle or lower body until air cylinders lightly touch lower spring protector and upper spacer. **NOTE-Check to be sure the air line does not kink or become pinched between the spacer and cylinder or floor board.**

G. Continue with step 13.

DO NOT INFLATE AIR CYLINDERS BEFORE READING MAINTENANCE/OPERATION TIPS.

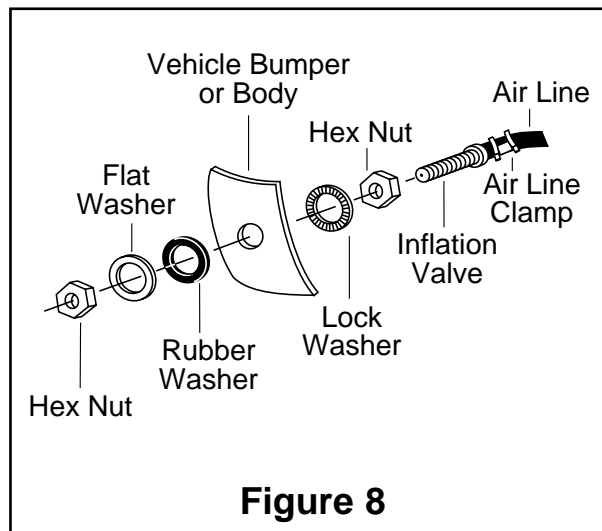

13. Inflate Air Springs to 35 p.s.i. Check for air leaks at all fittings and valve core with a soapy water solution.

14. Replace wheels, remove safety stands and carefully lower vehicle to ground.

15. Deflate Air Springs in 5 p.s.i. intervals to determine best ride and handing. Sufficient air pressure should be maintained to help prevent bottoming-out on large bumps, chuck holes, etc

16. Recheck air pressure after 24 hours. A 2-4 p.s.i. loss is normal after initial installation. If the pressure has dropped more than 5 p.s.i. re-test for leaks with a soapy water solution. Please read and follow the Maintenance and Operation Tips on page 4.

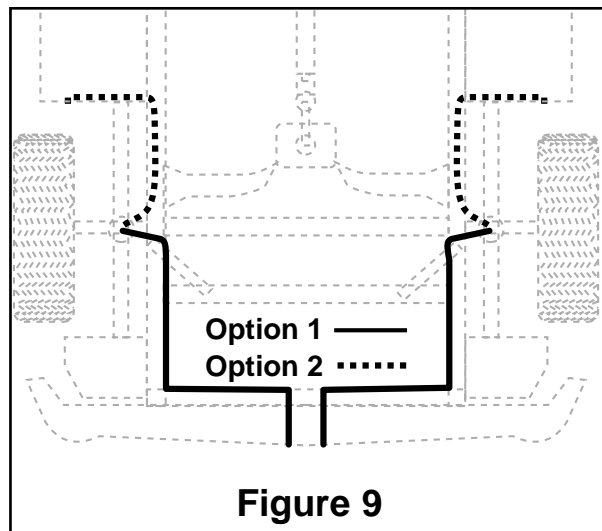

FAILURE TO MAINTAIN MINIMUM PRESSURE WILL VOID THE WARRANTY

MINIMUM AIR PRESSURE 5 P.S.I.	MAXIMUM AIR PRESSURE 35 P.S.I.
<p>MAINTENANCE TIPS:</p> <ol style="list-style-type: none">1. Check pressure weekly!2. Always maintain at least 5 p.s.i. air pressure to prevent chafing or coil pinch.3. If you develop an air leak in the system, use a soapy/water solution to check all air line connections and the valve core before removing cylinder. <p>OPERATING TIPS:</p> <ol style="list-style-type: none">1. Inflate your air springs to 35 p.s.i. before adding the payload. This will allow the air cylinder to properly mesh with the coil spring. After vehicle is loaded, adjust your air pressure (down) to level the vehicle and for ride comfort.2. When you are carrying a payload it will be helpful to increase the tire inflation pressure in proportion to any overload condition. We recommend a 2 p.s.i. increase above normal (not to exceed tire manufacturers maximum) for each 100 lbs. additional load on the axle.	
	<p><i>Thank you for purchasing Air Lift Products</i></p> <p>AIR LIFT COMPANY P.O. BOX 80167 Lansing, MI 48908-0167</p>
<p>FOR TECHNICAL ASSISTANCE CALL 1-800-248-0892</p>	
<p>Caution: DO NOT EXCEED THE VEHICLE MANUFACTURERS MAXIMUM GROSS VEHICLE WEIGHT RATING.</p>	